

montana

USER MANUAL

SIRIO

INDEX

1.0 General warning	4
1.1 Important safety information	4
2.0 OLI Sport system main features	6
2.1 How to switch on/off the OLI Sport system	6
3.0 Battery	6
3.1 Battery charge percentage	7
3.2 Battery installation and removal	7
3.3 Battery key	8
3.4 Battery cleaning	8
3.5 How to charge the battery	8
4.0 High Vision Display	9
4.1 Display control panel	9
4.2 Main screens	10
4.3 Assistance levels	12
4.4 Walk mode	12
4.5 Settings	13
4.6 Error codes	15
4.7 Technical assistance	16
4.8 Cleaning and maintenance	16
4.9 Disposal	17

Thank you for choosing an e-bike equipped with OLI motor.
Always wear protective clothing before using the e-bike.

1.0 GENERAL WARNING

Please read all the WARNING and information in this User Manual carefully before using the e-bike.

- Please contact the retailer for any information concerning the installation or adjustment of the e-bike that is not provided in this manual.
- This product must be disassembled or adjusted only by qualified personnel.
- This product must be used in compliance with the local laws and regulations.

!! WARNING – The use of batteries, battery chargers or other aftermarket accessories not approved by MONTANA S.R.L may compromise the normal functioning of the system and may cause damage. Moreover, it voids the warranty.

1.1 IMPORTANT SAFETY INFORMATION

!! DANGER – How to handle the battery:

- Do not deform, modify or disassemble the battery. Do not weld anything directly on the battery. It may cause leaks, overheating, explosions or battery fire.
 - Do not leave the battery next to heat sources such as heaters. Do not warm up the battery and do not throw it into the fire. This may cause explosions or battery fire.
 - Do not immerse the battery into liquids such as water and do not wet the connectors. This may cause overheating, explosions or battery fire.
 - Use only MONTANA S.R.L. approved battery charger to charge the battery and respect the requirements indicated for battery charging. Not following these requirements may cause overheating, explosions or battery fire.
 - Should any liquid leak from the battery and come into contact with your eyes, rinse the eyes with water without rubbing them and call your doctor. This may cause eye injury.
 - Do not charge the battery in highly humid places or outdoors. This may cause electric shocks.
 - Do not insert or remove the charging plug if it is wet. This may cause electric shocks. If there are traces of water on the charging plug, remove them before inserting it.
 - If the battery is not fully charged after 6 hours, remove the plug from the socket and contact the retailer. Not following these requirements may cause overheating, explosions or battery fire.
 - If there are scratches or visible damage on the battery, do not use it. This may cause explosions, overheating and other problems.
 - Do not use the battery when the temperature exceeds the range displayed below. This may cause battery fire, injuries or malfunction.
1. Using the e-bike: -20 °C / +60 °C;
 2. During the battery charge: 0 °C / +45 °C.

General rule for a safety ride

To avoid accidents, do not pay excessive attention to the display when you are riding your e-bike.

General rule for a safety use of the product:

Always remove the battery before wiring or connecting components to the e-bike. If not, it may cause electric shocks.

WARNING: Follow the rules contained in this User Manual for a safe and correct use of the e-bike.

Safe use of the product:

- Regularly check the condition of the battery charger, in particular the wire, the plug and the case. If the battery charger or the adapter are broken, do not use the battery until they are fixed up.
- People (kids included) with reduced physical, mental or sensorial capabilities must not use the e-bike unless they have been instructed on how to use it by someone responsible for their safety and supervision.

- Kids must not play too close to the e-bike.
- Contact the retailer for the installation and adjustment of the e-bike.
- Do not put the e-bike upside down. This may cause damage to the display or to the shift lever.
- Use the e-bike with care without exposing it to excessive stress.

WARNING: Do not use high-pressured water or steam jets to clean the motor, the display or the battery as they may cause damages or malfunctioning. Do not use high-pressured air jet to dry the e-bike.

How to handle the battery

- Do not leave the battery under the direct sunlight or inside of a vehicle if the temperature is high. This may cause leaks.
- Should the liquids leaked from the battery come into contact with your clothes or skin wash them immediately with water. The liquids may cause skin injuries.
- Store the battery in a safe place, away from the reach of children or pets.
- In case of malfunctioning or problems, contact your retailer.
- Do not modify the system, as this may cause malfunctioning.
- If the battery is removed from the e-bike, the vehicle works as a regular bike. Anyway, if the lights are connected to the battery, they can't be switched on.
- Pay attention to the following points if you charge the e-bike battery with the battery assembled on the frame:
 - *Make sure that there are no traces of water on the socket or plug.*
 - *Before charging the battery, make sure that the battery is correctly assembled and blocked.*
 - *Do not remove the battery during the charging.*
 - *Do not use the battery while it is connected to the battery charger.*
 - *Close the frame charging socket with its cover after every battery charge.*
- Remove the battery from the e-bike before loading it into your car.
- Before connecting the battery to the e-bike, make sure that there are no traces of water or dirt on the connectors.
- Keep away from the reach of children.
- Always remove the battery before cleaning the e-bike.

2.0 OLI SPORT SYSTEM MAIN FEATURES

To use the OLI Sport propulsion system, make sure that the following requirements are met:

- The battery must be sufficiently charged.
- The speed sensor must be correctly connected and the magnet correctly positioned.

The motor automatically deactivates when the e-bike reaches the speed of 25 km/h.

The motor automatically reactivates when the user restarts to pedal and the speed is less than 25 km/h.

As the user stops pedaling, the motor automatically deactivates. The motor reactivates as the user restarts pedaling. The motor cooperates and harmonizes with the user's effort.

2.1. HOW TO SWITCH ON/OFF THE OLI SPORT SYSTEM

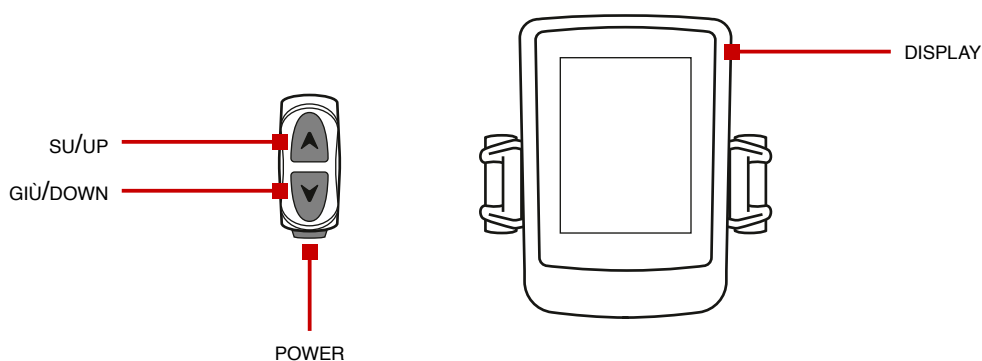

SWITCHING THE SYSTEM ON:

Press and hold the POWER button until the initial screen with the OLI logo is displayed. After a few seconds the first Home section is displayed.

SWITCHING THE SYSTEM OFF:

Press and hold the POWER button until the shutdown screen is visualized. Wait a few seconds for the whole system shutdown.

PLEASE NOTE: If the E-bike is not used for a certain amount of time, depending on the type of battery, the system will switch off automatically.

3.0 BATTERY

!! DANGER: Use only the specific battery charger and follow the charging requirements indicated in this User Manual. If not, it may cause overheating, explosion or battery fire.

WARNING:

- Do not unplug the battery charger from the socket by pulling the cable, but gently unplug the plug.
- If the battery charger is connected to the frame socket for battery charging, pay attention not to stumble in the battery charger cable. This may cause injuries or the bicycle to drop with consequent damages to the components.
- If the e-bike is stored for a prolonged period of time after the purchase, it will be necessary to charge the battery again before using the e-bike.
- The warranty does not cover the battery for wearing and deterioration determined by the regular and normal use of the e-bike.

3.1 BATTERY CHARGE PERCENTAGE

The battery charge percentage is displayed in every Home screen.

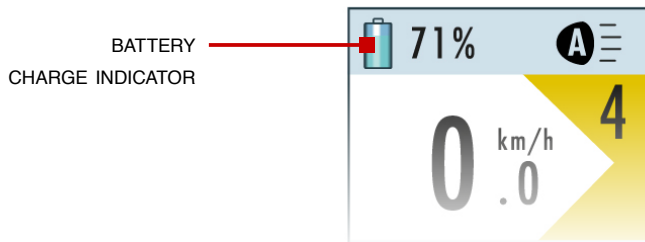

3.2 BATTERY INSTALLATION AND REMOVAL

WARNING: Always remember to switch off the battery before the battery installation or removal.

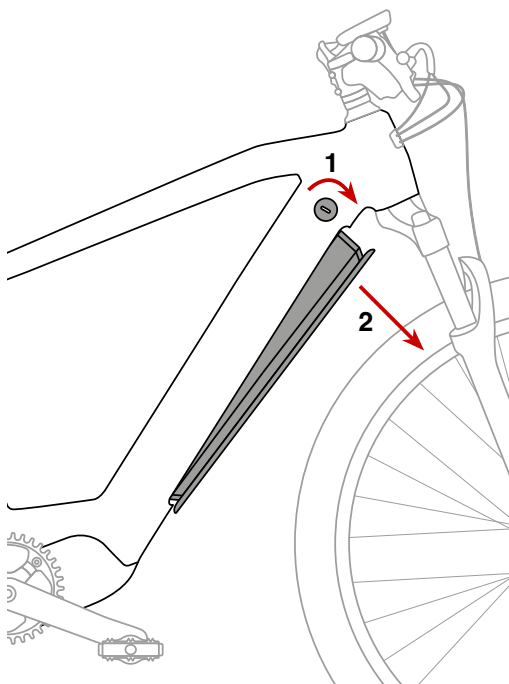

BATTERY REMOVAL

1. Insert the key into the lock and turn it clockwise to unlock the battery.
2. Grab the upper part of the battery and remove it from the support.

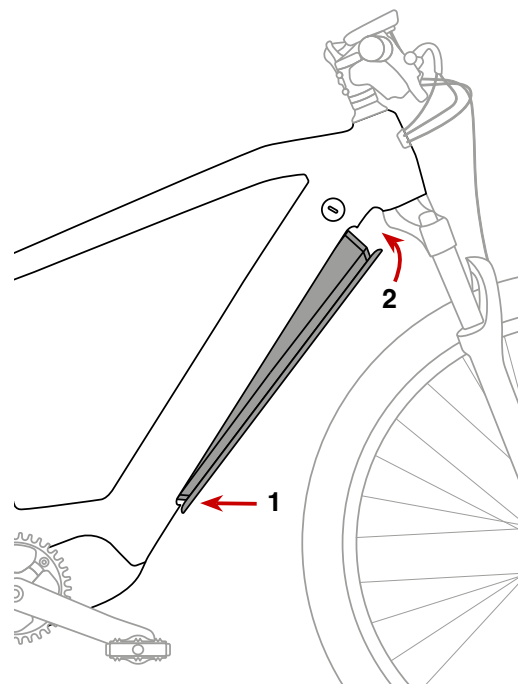

BATTERY INSTALLATION

1. Insert the lower part of the battery into the down tube opening paying attention to avoid ruining the rubber gaskets, and then connect the upper part to the electric connectors.
2. The “click” sound indicates that the battery is correctly locked. There is no need to insert the key to assemble the battery.
3. During this operation make sure to handle and assemble the battery with care to avoid damages to the electric components and connectors.
4. Remove the key from the lock and store it in a safe place.

!! DANGER: Do not use the e-bike with the key on. This may cause the battery to drop or the key to be lost.

WARNING:

- Before using the e-bike make sure that the battery is locked and that the charging socket cover is closed.
- Remove and store the battery in a dry place before transporting the e-bike; cover and protect the electric connectors from weather elements.

3.3 BATTERY KEY

In case of key loss, contact your retailer. He will replace the whole padlock.

3.4 BATTERY CLEANING

- Do not use diluents or solvents to clean the e-bike parts. Such products may damage the components.
- Use a damp cloth to clean the battery and plastic parts.
- The battery is designed to be completely waterproof and, when assembled, it can be used also in case of rain. Anyway, when it is not assembled on the e-bike, the battery must not enter into contact with water as in this case the connectors are not protected.
- Do not clean the battery with high-pressured jets. This may cause malfunctioning.
- Remove the battery before cleaning the e-bike.

3.5 HOW TO CHARGE THE BATTERY

- At the moment of the purchase the battery is not completely charged. Before using the e-bike it is necessary to charge the battery completely. If the battery runs out of charge, it will be necessary to charge it as soon as possible. If not, the battery lifetime will tend to reduce considerably.
- At the moment of storing the e-bike for a prolonged period of time, the battery charge must be around the 70% of its total capacity. Moreover, it is recommended to charge the battery for around 2 hours each 3 months to avoid the complete battery discharge.

HOW TO CHARGE THE BATTERY WHEN DISASSEMBLED

1. Insert the battery charger plug into the socket.
2. Insert the battery charger adapter into the battery socket. Leave the battery on a flat surface during the charging.

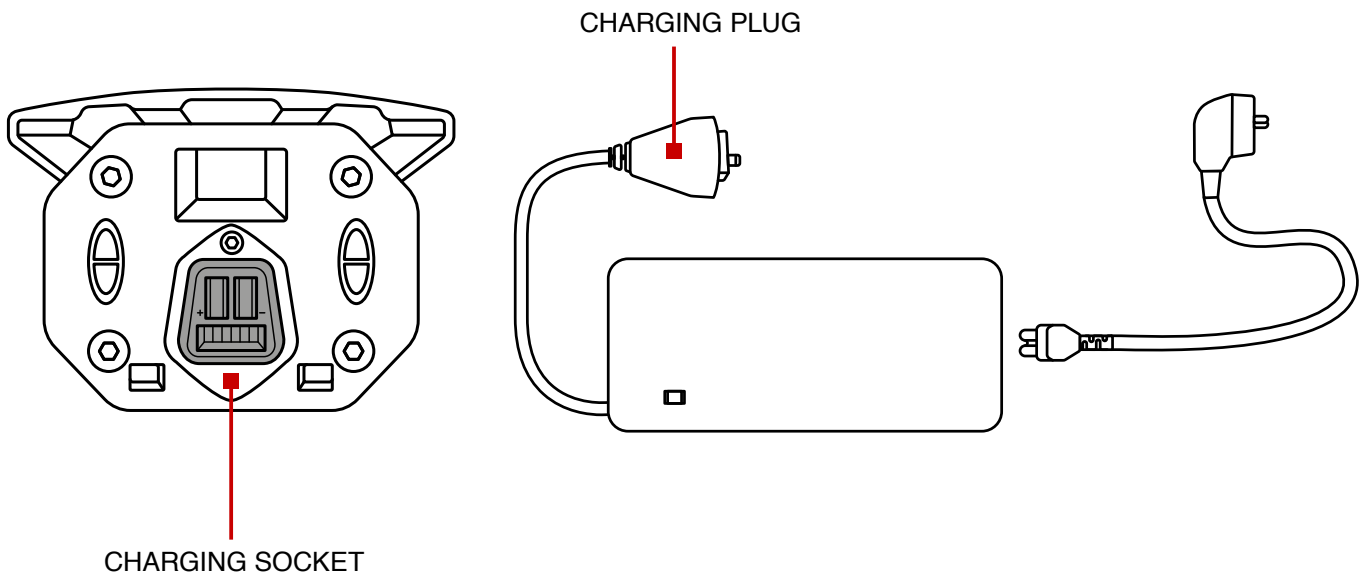

HOW TO CHARGE THE BATTERY INSTALLED ON THE FRAME

1. Switch off the system.
2. Secure the e-bike to avoid any fall during the battery charge.
3. Insert the battery charger power plug into the socket.
4. Insert the battery charger adapter into the frame socket.

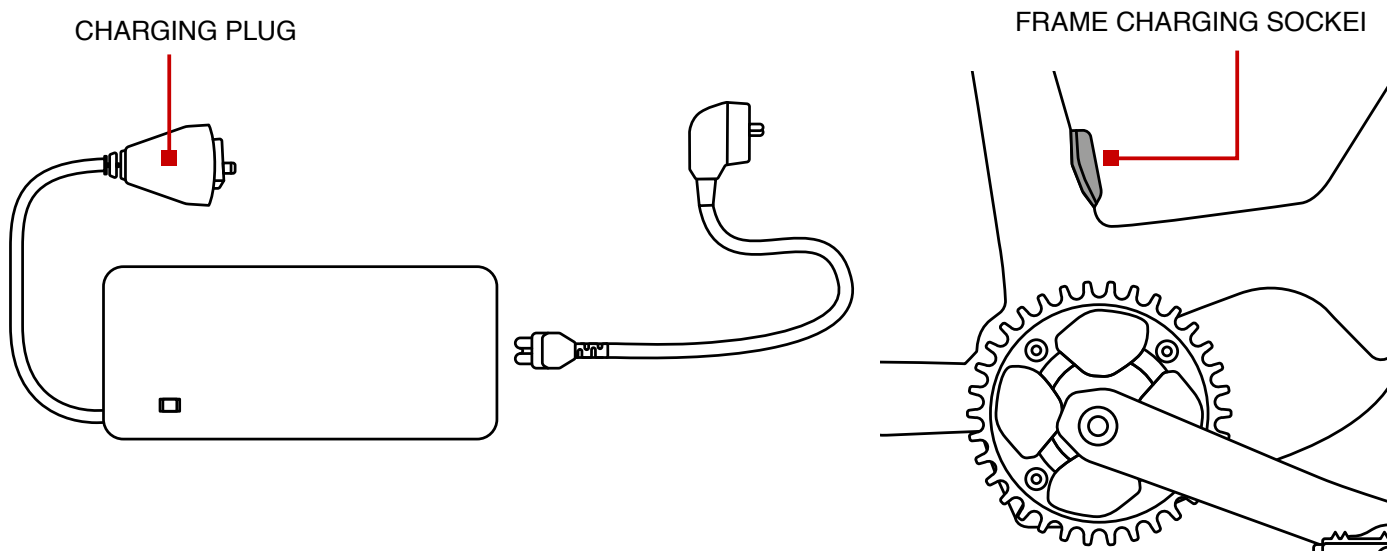

WARNING:

- If the battery (17.5 Ah) is completely discharged, it will take 10 hours to complete the charge.
- If the battery (14.5 Ah) is completely discharged, it will take 7/8 hours to complete the charge.
- Follow the safety rules contained in this manual during the battery charge.
- Check and remove any trace of dirt from the battery charge connectors and sockets.
- A possible interruption during the battery charge won't cause damages to the battery.
- If the battery is charged when the battery is assembled on the e-bike, close the frame charging socket cover after each charge.

4.0 HIGH VISION DISPLAY

WARNING: Using the display during the ride may distract the user and cause accidents. Always follow the traffic regulations.

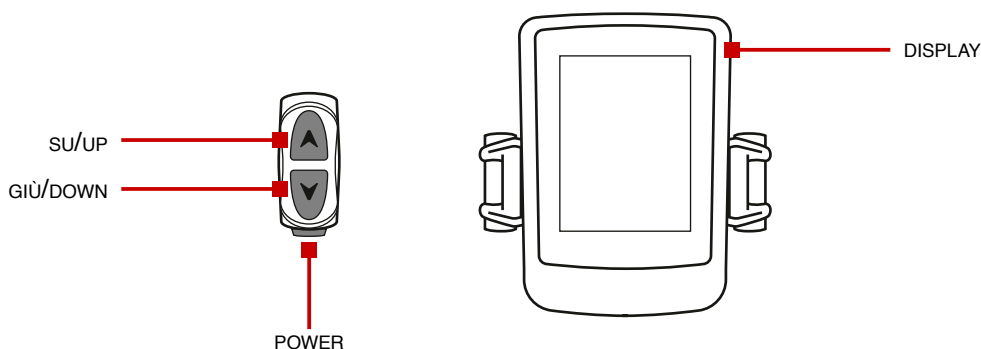

4.1 DISPLAY CONTROL PANEL

The display is provided with 3 buttons that allow the user to navigate within the software. They can be used either with a short pressing or a prolonged pressing (more than 2 seconds).

BUTTON	SHORT PRESSING (<1 SEC)	LONG PRESSING (>2 SEC)
POWER	Allows you to:	Allows you to:
UP	scroll on the Home screen from one main screen to another;	turn the display on or off;

BUTTON	SHORT PRESSING (<1 SEC)	LONG PRESSING (>2 SEC)
DOWN	Allows you to scroll through the menu items, going down	From any main screen allows you to activate Walk mode
DOWN + UP	-	From the main screens, pressing the two keys simultaneously allows access to the Menu

4.3 MAIN SCREENS

HOME

After powering on, the first Distance screen of the Home section is displayed.

The Home section consists of 6 screens.

To scroll through the screens you need to press the POWER button.

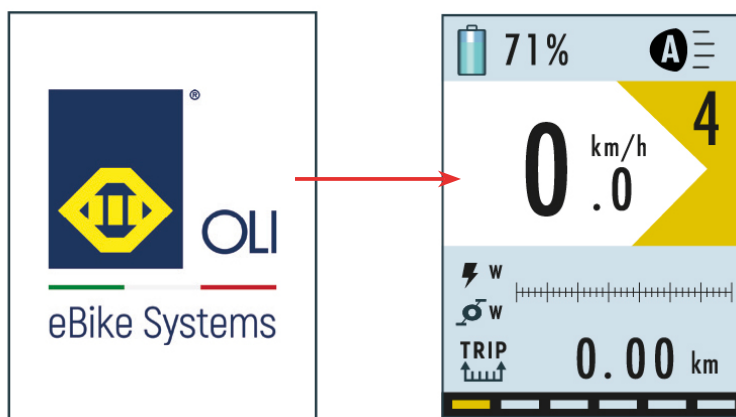

From any screen in the Home section, you can:

- Adjust the assistance level by pressing the UP and DOWN buttons.
- Enter Walk mode by holding down the DOWN button.
- Adjust the brightness of the e-bike lights by holding down the UP button for 2”.
- Enter the Menu section by holding down the UP and DOWN buttons at the same time for 2”.

GENERAL SCREEN LAYOUT

The screens in the Home section differ from each other in the type of information displayed.

From screens 1, 2, 3 and 4 it is always possible to visualize the following information:

1. Battery charge percentage;
2. E-bike light adjustment;
3. Assistance level;
4. Current e-bike speed (in km/h);
5. Power graph display (upper bar: motor power; lower bar: cyclist power);
6. Navigation bar.

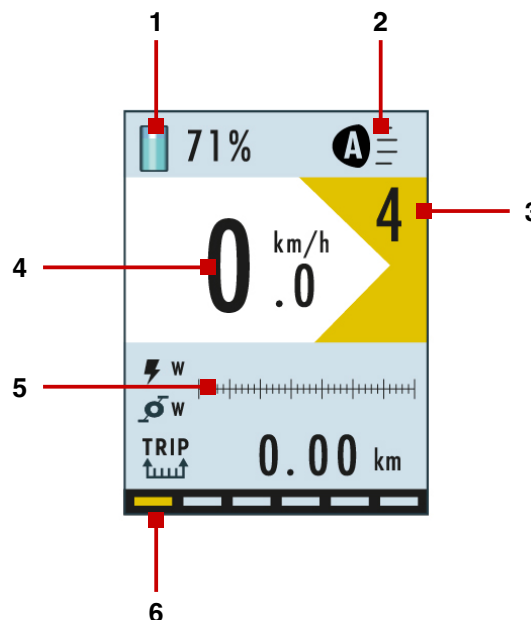

TRIP **SCREEN 1 – TRIP**

Indicates the distance travelled in kilometers (km) since the last reset.



SCREEN 2 – TIME

Indicates the time elapsed in motion since the last reset. The value is expressed in hours:minutes:seconds.



SCREEN 3 – PACE

Indicates the instantaneous speed of rotation of the rotating pedals per minute (rpm).



SCREEN 4 – ENERGY

Indicates the energy consumed by the cyclist in kilocalories (kcal) since the last reset.



SCREEN 5 – RACE

It is the fifth screen of the Home section.

In this screen, the values in watts (w) of the motor power and cyclist power are expressed in full.

1. Indicates the instantaneous power delivered by the moto in watts (w).
2. Indicates the instantaneous power expressed by the cyclist in watts (w).
3. Power graph display (upper bar: motor power; lower bar: cyclist power).
4. Indicates the average energy consumption in watt-hours per kilometer (Wh / km), calculated since the last reset.

This data allows you to adjust the level and, therefore, the consumption of the e-bike according to the need.

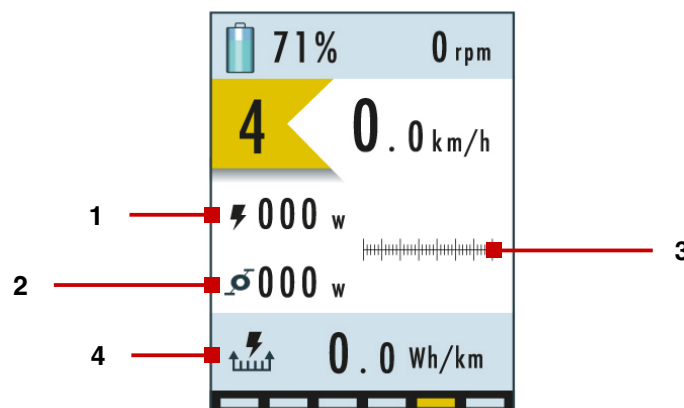



SCREEN 6 – SUMMARY

It is the sixth screen of the Home section. This screen summarizes the variable parameters of the previous screens.

TRIP  Indicates the distance travelled in kilometers (km) since the last reset.

 Indicates the time elapsed in motion since the last reset. The value is expressed in hours:minutes:seconds.

 Indicates the average speed in kilometers per hour (km/h) measured since last reset.

 Indicates the average energy consumption in watt-hours per kilometers (Wh/km) calculated since the last reset.

 Indicates the energy consumed by the cyclist in kilocalories (kcal) since the last reset.

ODO  Indicates the total distance travelled by the e-bike in kilometers (km). Non-resettable value.



4.3 ASSISTANCE LEVEL

From any screen in the Home section is possible to change the assistance level by pressing the UP button to increase it and the DOWN button to decrease it.

Below you can find the multiplication factor for each level of assistance:

- **LEVEL 0:** 0% (motor inactive);
- **LEVEL 1:** 50%;
- **LEVEL 2:** 100%;
- **LEVEL 3:** 200%;
- **LEVEL 4:** 300%;
- **LEVEL 5:** 400%.

4.4. WALK MODE

The system is equipped with a walk assistance function, which allows you to activate the motor up to a maximum speed of 6 km/h.

To activate the walk assistance function, press and hold the DOWN button.

The motor will start in Walk mode and the corresponding icon will appear on the display.

To deactivate Walk mode, release the DOWN button.

The motor will shut down in the following cases:

- Release of the DOWN button;
- Speed exceeding 6 km/h;
- Locking the e-bike wheel.

WARNING: If assistance level (0) is set, the motor is disabled and the walk assistance function cannot be used.

4.5 MENU

From the Home section, hold down the UP + DOWN buttons at the same time for 2” to enter the Menu section.

From the Menu page:

- Use the UP and DOWN buttons to scroll through the items present, the selected item is highlighted in the center in the white line;
- Press the POWER button to confirm and open the page of the selected item; the Back item takes you to the first screen of the Home section.

From any screen, by holding down the POWER buttons for 2”, you can return to the last viewed HOME screen.

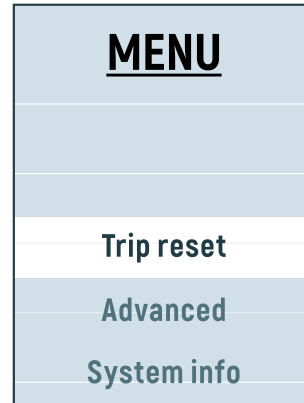

RESET TRIP

The Reset trip item allows you to reset all the recorded lap data by returning the counters to zero.

By pressing the POWER button it starts immediately upon reset.

The message “Trip reset...” appears on the display for a few seconds, when the reset is complete, the Menu page is displayed again.

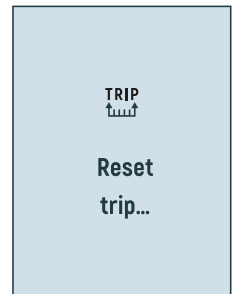

SYSTEM INFO

In this screen you can view the firmware versions:

- Of the installed HMI;
- Of the associated motor.

Press the POWER button to return to the Menu.

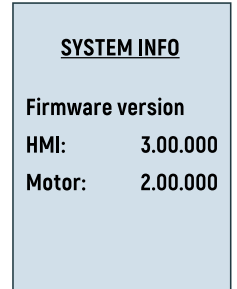

ADVANCED:

From the Menu section it is possible to access the Advanced section by selecting the relevant item.

From the Advanced page:

- Use the UP and DOWN buttons to scroll through the items, the selected item is highlighted in the center in the white line;
- Press the POWER button to confirm and open the page of the selected item, the Back item takes you back to Menu page.

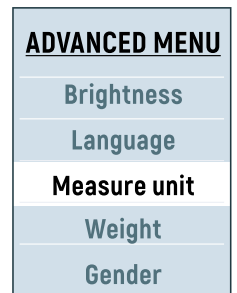

SCREEN BRIGHTNESS

From this screen, you can adjust the brightness of the screen.

Use the UP and DOWN buttons to scroll through the values from 1 to 10. The selected value is highlighted in the center in the white line.

Press the POWER button to confirm and return to the Advanced page.

Select the Back item and press the POWER button to return to the Advanced page without setting any value.

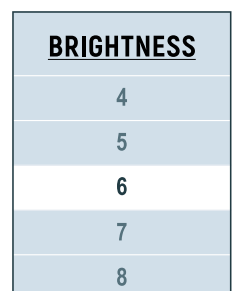

LANGUAGE

From this screen you can choose the language of the unit's text.

Use the UP and DOWN buttons to scroll through the available items. The selected value is highlighted in the center in the white line.

Press the POWER button to confirm and return to the Advanced page.

Select the Back item and press the POWER button to return to the Advanced page without changing the language.

LANGUAGE
Italiano
English
Français
Deutsch
Español

MEASURE UNIT

From this screen it is possible to select the unit of measure with which the following are calculated:

- Instantaneous speed;
- Average speed;
- Average consumption;
- Lap distance;
- Total distance.

Use the UP and DOWN buttons to scroll through the available items. The selected value is highlighted in the center in the white line.

Press the POWER button to confirm and return to the Advanced page.

Select the Back item and press the POWER button to return to the Advanced page without changing the unit of measure.

MEASURE UNIT
Km
Miles
Back

WEIGHT

From this screen you can set your body weight by choosing a value between 50 and 150 kg.

WARNING: Setting this datum is not necessary for the e-bike to function correctly. The value has the sole purpose of making the calculation of the calories consumed reliable.

Use the UP and DOWN buttons to scroll through the available items. The selected value is highlighted in the center in the white line.

Press the POWER button to confirm and return to the Advanced page.

Select the Back item (located after item 150) and press the POWER button to return to the Advanced page without changing the weight.

WEIGHT
68
69
70
71
72

GENDER:

From this screen you can set your gender.

WARNING: Setting this datum is not necessary for the e-bike to function correctly. The value has the sole purpose of making the calculation of the calories consumed reliable.

Use the UP and DOWN buttons to scroll through the available items. The selected value is highlighted in the center in the white line.

Press the POWER button to confirm and return to the Advanced page.

Select the Back item and press the POWER button to return to the Advanced page without changing the gender.

GENDER
Male
Female
Back

NIGHT MODE:

From this screen you can choose the configuration for night mode:

- Automatic, the night mode is set automatically by means of the twilight sensor inside the display, which detects the ambient brightness.
- Active, night mode always active.
- Deactivated, night mode always deactivated.

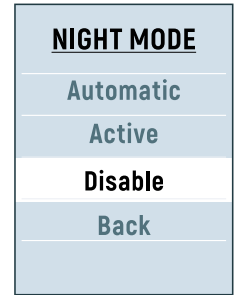

Use the UP and DOWN buttons to scroll through the available items. The selected value is highlighted in the center in the white line.

Press the POWER button to confirm and return to the Advanced page

Select the Back item and press the POWER to return to the Advanced page without changing the configuration.

4.6 ERROR CODES

In the event of a fault, the system signals the problem to the user by displaying a danger icon combined with 4-character code, which allows the user to trace the type of error.

WARNING:

- Depending on the type of fault, the system may prevent the motor from starting or run at reduced power.
- Where “request assistance” is indicated, the intervention of an OLI E-bike Systems technician is required.

The following table lists the possible faults and the 4-character codes displayed in the error messages.

ERROR	PROBLEM	SOLUTION
0001	Battery communication problem. Battery status data may be displayed incorrectly.	Check that the battery cables and contacts are intact and connected correctly.
0101	Communication problem between power unit and HMI.	
0104	Speed sensor not detected.	Check that the wiring is intact and connected correctly.
0105	Non-compliant torque meter signal. The torque meter signal has a fault. Reduced power operation.	Check that the speed sensor is installed and connected correctly.
0106	Non-compliant torque meter offset. The torque meter signal has a fault.	Request assistance.
0801	Motor rotation sensors fault	Request assistance.
0802	Pedal rotation sensors fault	Request assistance.
0804	Excessive drive temperature.	Request assistance.
0805	Excessive motor temperature. The motor has reached a temperature above the danger threshold.	Shut down the system temporarily to allow the components to cool.
0806	Non-compliant peripheral bus voltage	If it occurs frequently, ask for assistance.

0808	Locked rotor. The motor failed to start due to a mechanical lock or a problem with the internal wiring of the power unit	Request assistance
0809	The battery voltage is higher than the maximum allowed	Request assistance
0810	Non-compliant current sensor signal	Possible battery defect, try alternative or new battery.
0811	The drive has detected an overcurrent	Request assistance.
1101	Communication problem between power unit and HMI. Check that the wiring is intact and connected correctly.	Check the cable connections by removing the motor.
1102	A button on the keypad is stuck in a pushed position	Try moving the buttons on the keypad. If this does not resolve, please request assistance.

4.7 TECHNICAL ASSISTANCE

Ordinary and extraordinary maintenance must be carried out in accordance with the instructions contained in this manual.

WARNING: The manufacturer declines all responsibility for damage to person or property, as well as for the faulty operation of the unit, in the event of:

- Improper use of the unit;
- Errors in use or inexperience, imprudence or negligence with respect to the indications and instructions container in this manual;
- Use of non-original spare parts.

REQUEST FOR ASSISTANCE

In case of error codes that require assistance, problems that could not be solved with the suggested indications, problems not indicated and for any kind of assistance, it is recommended to contact the manufacturer directly.

Data to be reported in the request for assistance:

- Model (see identification plate);
- Serial number (see identification plate);
- Year of construction (see identification plate);
- HMI version;
- Motor version.

Correct reference of the data when requesting for assistance guarantees quick and accurate answers.

4.8 CLEANING AND MAINTENANCE

None of the components must be immersed in water or cleaned with a high-pressure jet.

To clean the HMI unit, use a cloth moistened with water.

WARNING: Never use aggressive products or abrasive powders or basic or acid chemical detergents. The manufacturer declines all responsibility for damage caused by incorrect cleaning or resulting from the use of unsuitable products.

4.9 DISPOSAL

HMI unit, display, keypad, various accessories and packaging must be disposed of in compliance with the environmental regulations in force.

When the unit is put out of service and dismantled, it is necessary to separate the plastic parts and the electrical components, which must be sent to the separate collection centres in compliance with the regulations in force. The metal parts must be separated for correct recycling. Electric and electronic components, marked with a special symbol, must be disposed of in authorized collection centres.

Illegal disposal of “Waste Electrical Electronic Equipment” (WEEE) is punished with sanctions regulated by the laws in force on the matter.

WARNING: The disposal must be carried out by qualified personnel.

MONTANA S.R.L.

Via Domenico Rossi 70, 12060 Magliano Alpi (CN) - Italy

Tel. +39 017466828 - Fax +39 017466651

montana@montanabike.com - www.montanabike.com